



NARROW SINGLE POLE TOGGLE FOR USE WHERE SPACE IS LIMITED

The T71 toggle is ~35 percent narrower than OTTO's T7 toggle making it a great alternative for use in rugged, high-demanding applications where space is limited.

Sealed to both IP68S and IP69K, the thinner T71 series is available in single pole single throw (SPST) and single pole double throw (SPDT) configurations. High contact pressure and superior contact wiping action of the OTTO design makes the T71 an excellent choice for switching loads from logic level up to 16 amps. These toggles feature positive detent action for safe switching operation. In conjunction with the unique OTTO snap-action switch mechanism, the T71 offers non-teasible contact transfer.

Designed for tight spaces in control panels and grips, the T71 can be used under severe conditions found in heavy equipment, industrial control, marine and appliance applications.

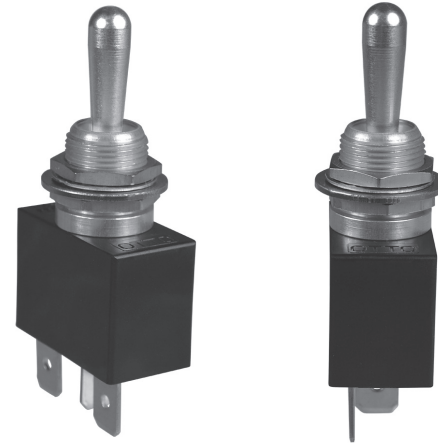

Features:

- Thin version of OTTO's T7 toggle
- Single pole only
- Sealed to IP68S and IP69K
- Switches logic level up to 16 amps
- Withstands extreme shock & vibration
- Positive detent, non-teasible contact transfer
- 2 & 3 position, momentary & maintained action
- Choice of terminal styles
- RoHS compliant
- Black matte finish available (contact factory)

Standard Characteristics/Ratings:			
ELECTRICAL RATINGS:			
Load	Sea Level @ 28VDC	Sea Level @ 125VAC 60/400 Hz	Cycles
Resistive	16A	5A	25,000
Resistive	10A	N/A	50,000
Inductive	7A	2A	25,000
DWV	1000Vrms	1000Vrms	1000Vrms
Logic Level	10mA @ 5VDC	N/A	50,000
Electrical Life:	See Rating Chart		
Mechanical Life:	100,000 cycles		
Seal:	IP68S and IP69K		
Operating Temp Range:	-30°C to +85°C		
MATERIALS:			
Case:	Thermoplastic		
Bushing:	Anodized aluminum alloy		
Toggle:	Stainless steel		
Contacts:	Fine silver/silver cadmium oxide		
Logic Level Contacts:	Gold over silver		
Mounting Hardware:	Hex nuts, lockwasher, keyway washer		

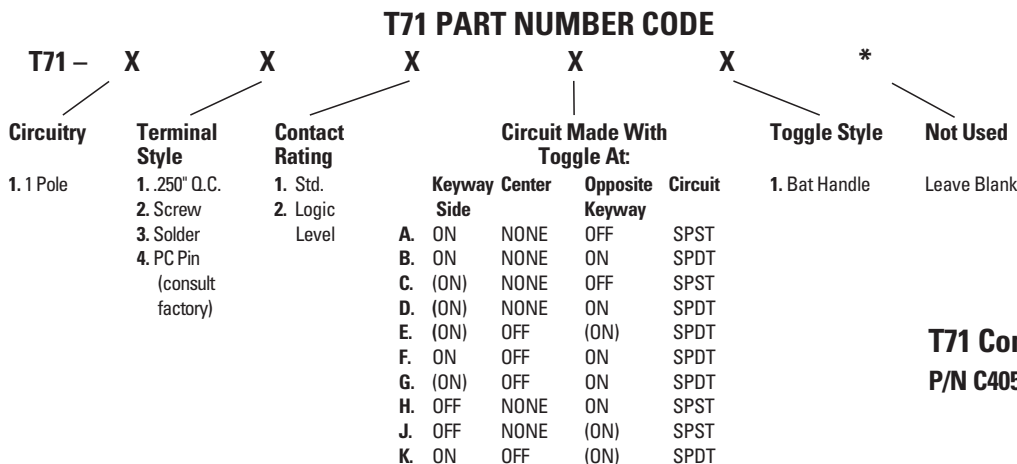

T71 Connector
P/N C405041

NOTE: () denotes momentary action.

SEALED TOGGLE SWITCHES

DESIGNED FOR TIGHT SPACES AND SEVERE CONDITIONS

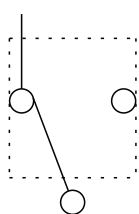
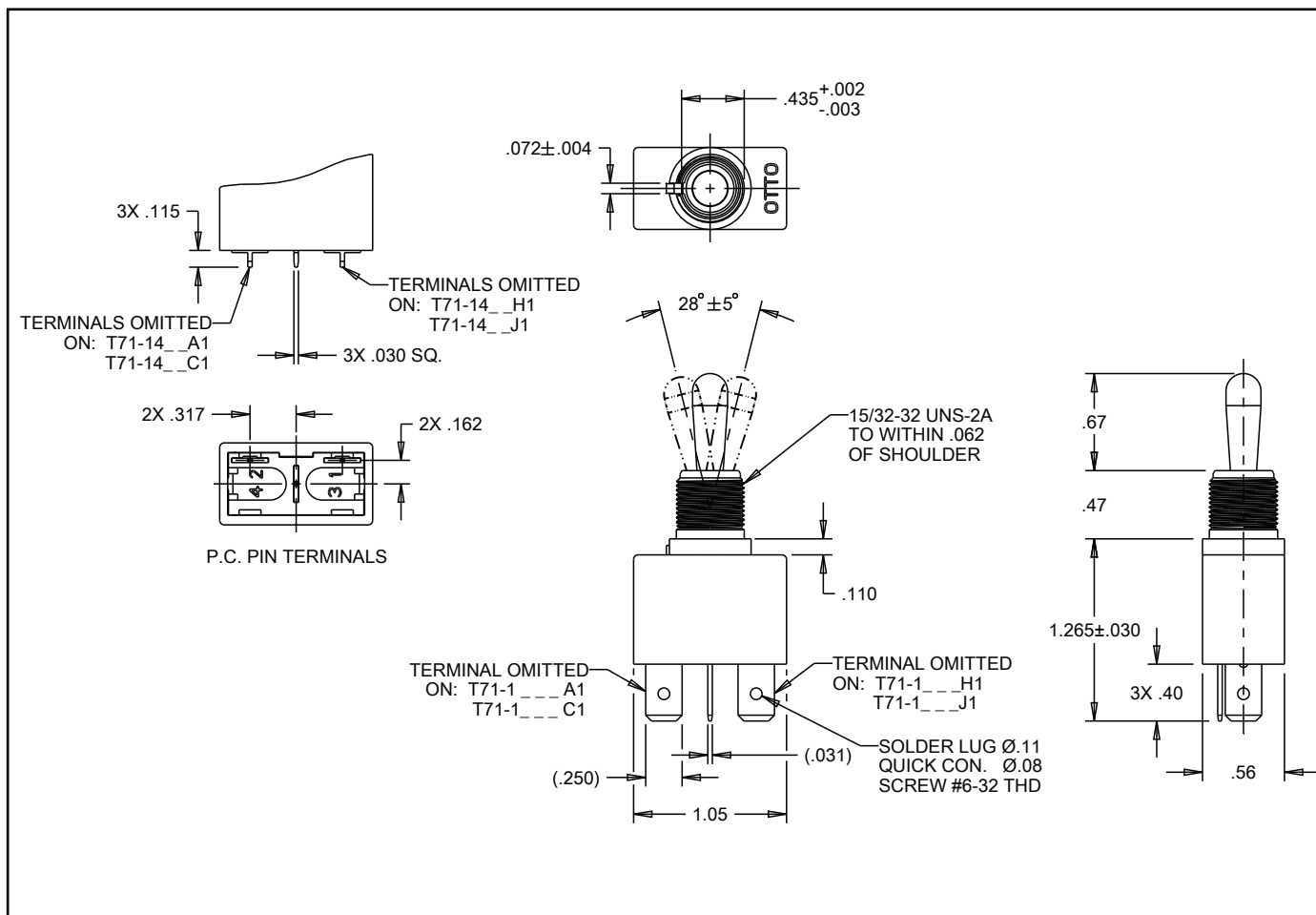

ON OFF

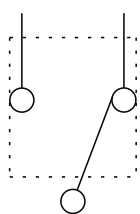

ON ON

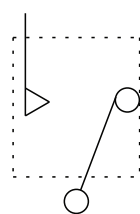

(ON) OFF

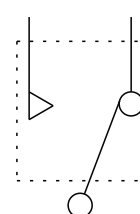

(ON) ON

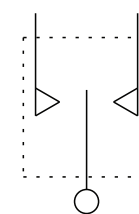

(ON) OFF (ON)

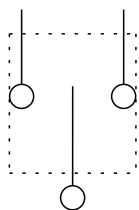

ON OFF ON

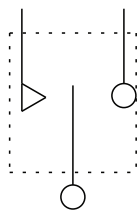

(ON) OFF ON

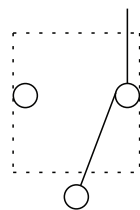

OFF ON

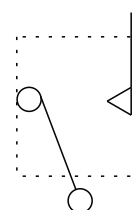

OFF (ON)

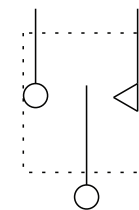

ON OFF (ON)